

J275 HA V2 H800

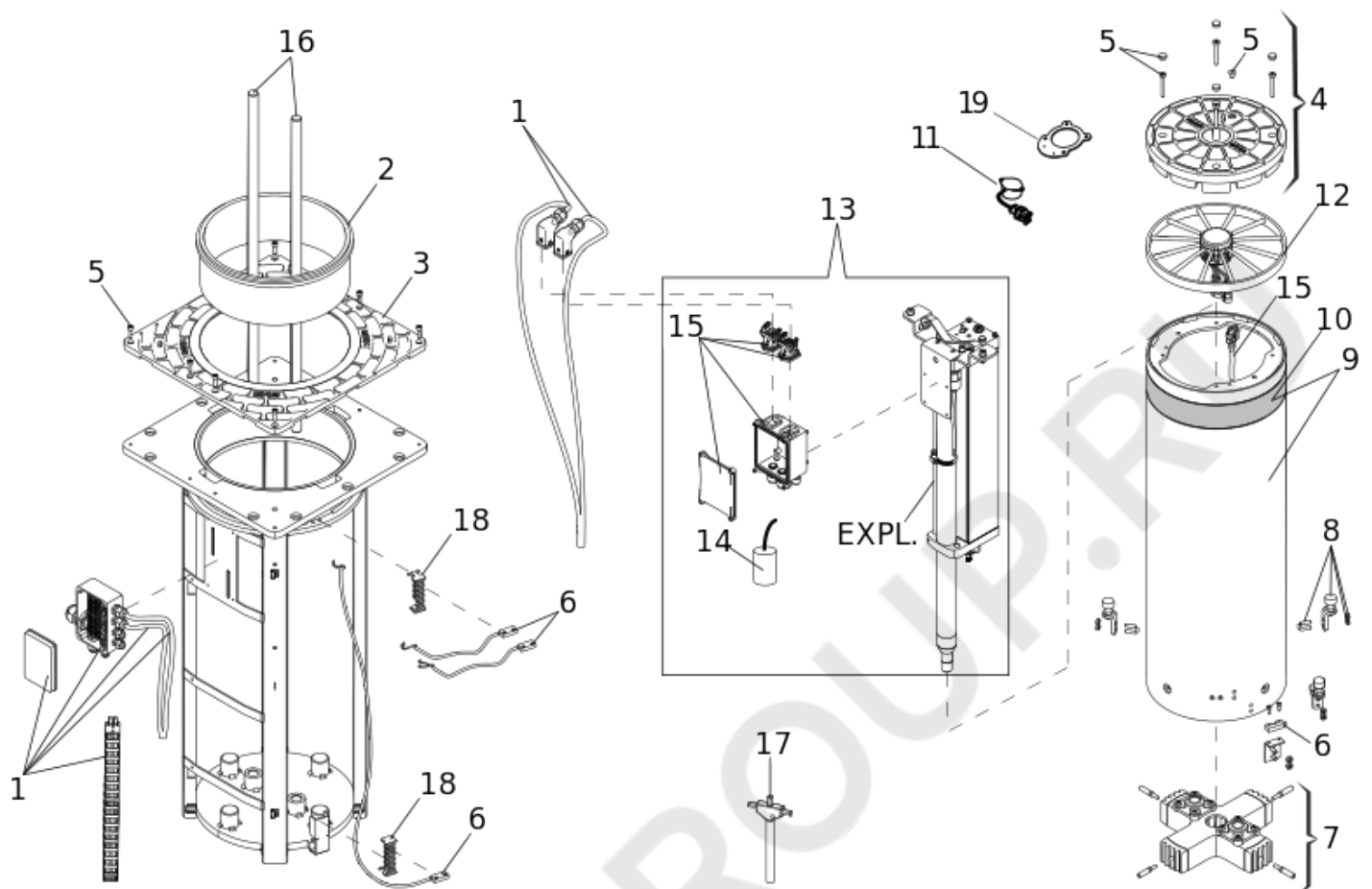

Pos.	Code	EAN	Quantity	Replacement code	Description	Salable
1	63000957	8055195032086	1		ASSEMBLY WIRED J275HA	yes
2	63002255	8055195033175	1		TOP BUSH FOR J275HH	yes
3	63003393	8055195061697	1		COVER FOR J275 (RILSAN)	yes
4	63003394	8055195061680	1		J275 HA HEAD (RILSAN)	yes
5	63003396	8055195061710	1		J275 ACCESSORIES (2020)	yes
6	63002215	8055195033137	1		END STOP CONTACT ASS. - J275HA	yes
7	63000896	8055195031959	1		GUIDE CARRIAGE J275HA	yes
8	63002225	8055195033144	4		END STOP PUFFERT ASS. - J275HA	yes

Pos.	Code	EAN	Quantity	Replacement code	Description	Salable
9	63000936	8055195032048	1		CILINDER W/STICKER J275HA H800	yes
10	63000167	8055195029345	1		YELLOW REFLECTING STICKER FOR J275HA	yes
11	63000593	8055195031324	1		J275HA WIRED BUZZER	yes
12	63000594	8055195031331	1		J275 LED LAMP	yes
13	63000541	8055195030983	1		ACTUATOR COMPLETE J275 HA_V2 H800	yes
14	7601201	8055195025910	1		PP CAP.16 MF 230VAC WIRE 180MM	yes
15	63000178	8055195029444	1		NEW JUNCTION BOX HYDRAULIC UNIT J275HA	yes
16	63002595	8055195033373	1		GUIDE ROD MOVING BOLLARD H800	yes
17	63000281	8055195030105	1		J200HA RELEASE KEY	yes
18	63000228	8055195029673	2		J275HA REED SENSORS SUPPORT	yes
19	63003506		1		BUZZER SUPPORT	yes

J275 HA V2 H800 HYDRAULIC UNIT

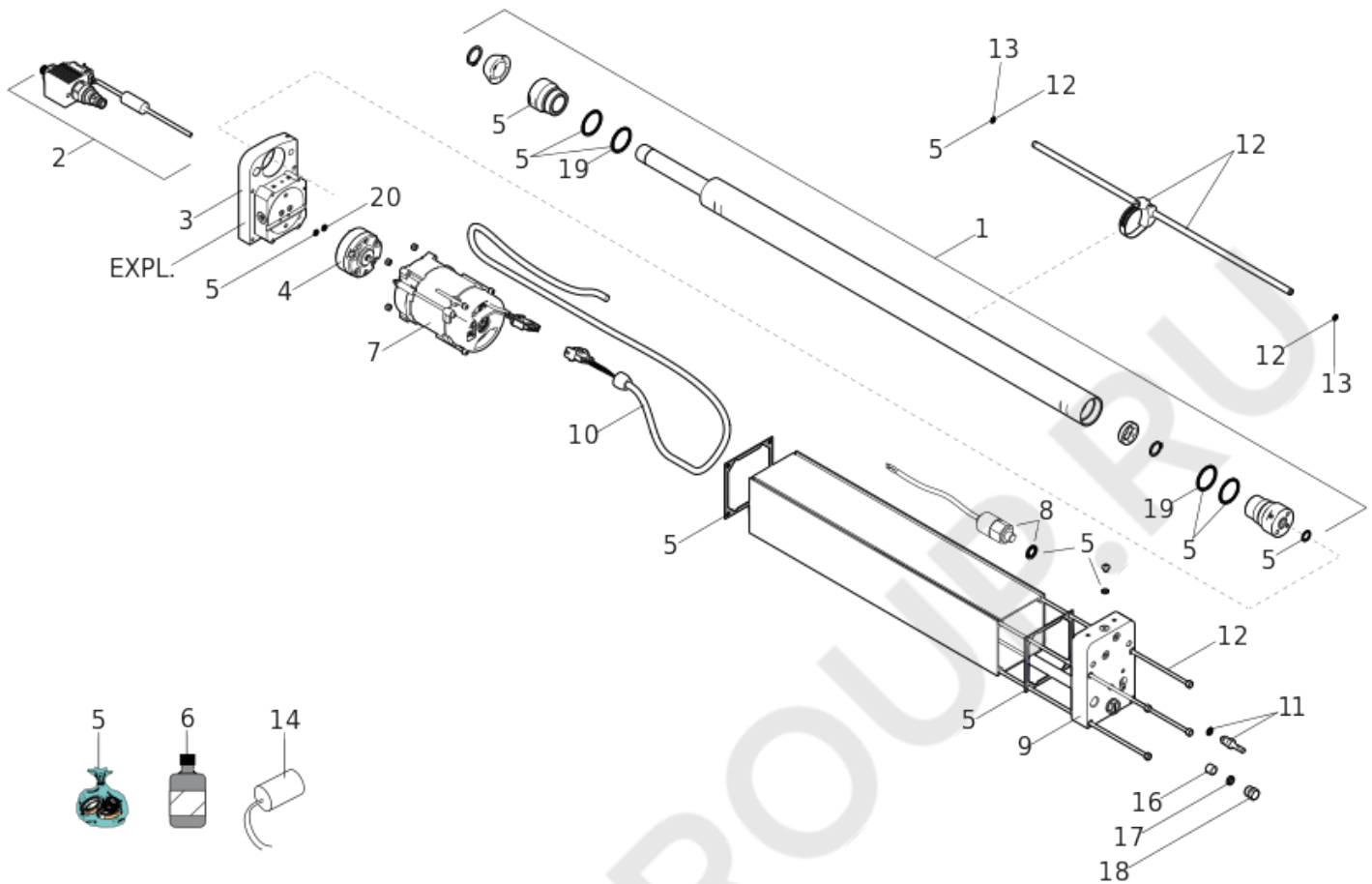

Pos.	Code	EAN	Quantity	Replacement code	Description	Salable
1	63000538	8055195030969	1		PLUNGER PISTON J275 HA_V2 H800	yes
2	116211	8055195052572	1		J275 Solenoid Valve	yes
3	63001016	8055195032307	1		FLANGE J275HA	yes
4	63001006	8055195032222	1		CAST IRON PUMP LT. 1 HP	yes
5	63003458	8055195063844	1		J275 HA GASKETS KIT (2021)	yes
6	714017	8055195010923	2		FAAC HP OIL LT.1	yes
7	7704065	8055195026023	1		MOTOR 220V 2P	yes
8	116210	8055195052565	1		J275 PRESSURE SWITCH	yes

Pos.	Code	EAN	Quantity	Replacement code	Description	Salable
9	63001026	8055195032345	1		TOP FLANGE J275HA	yes
10	7514075	8055195025743	1		CABLE M.1.8 W/O MOTOR THERMAL PROT.	yes
11	63003166	8055195033847	1		RELEASE VALVE ASSEMBLY J275/J200 HA	yes
12	63003298	8055195057492	1		J275HA OIL PIPE AND TIE RODS	yes
13	7090635	8055195022407	2		ORM SEAL 5x1,5 (0050-15)	yes
14	7601201	8055195025910	1		PP CAP.16 MF 230VAC WIRE 180MM	yes
16	7043355	8055195022131	1		CABLE GLAND RING	yes
17	7099245	8055195022841	1		STRAIN RELIEF GASKET	yes
18	7109095	8055195022957	1		CABLE GLAND	yes
19	7090380025	8055195040272	2		GASKET OR 29.82X2.62 (3118)	yes
20	7090010015	8055195040074	2		GASKET OR 4.48X1.78 (2018)	yes

J275 HA DISTRIBUTION FLANGE

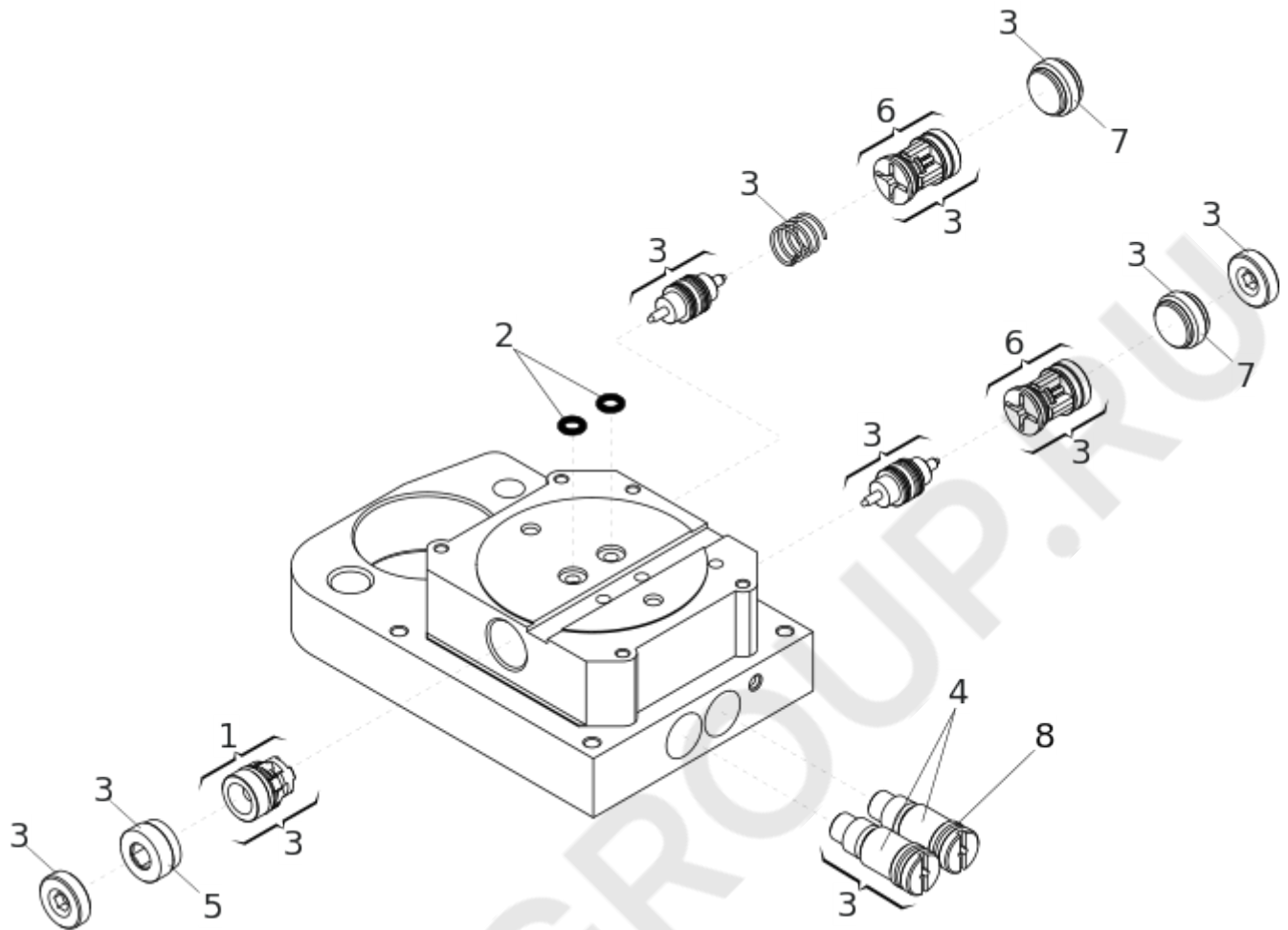

Pos.	Code	EAN	Quantity	Replacement code	Description	Salable
1	63001047	8055195032383	1		OIL ASPIRATOR VALVE WITHOUT SPRING	yes
2	7090010015	8055195040074	2		GASKET OR 4.48X1.78 (2018)	yes
3	63003299	8055195057508	1		J275HA VALVES GROUP	yes
4	4180395	8055195015508	2		BY PASS BRASS CAP	yes
5	7049135	8055195022186	1		VALOX VALVE RETAINING RING NUT	yes
6	63003460	8055195063875	2		STOP VALVE IN ZAMAK +GF10 BOX	yes
7	63000421	8055195030525	2		VALVE RETAINING RING NUT	yes

Pos.	Code	EAN	Quantity	Replacement code	Description	Salable
8	7090150015	8055195040135	2		GASKET OR 9.25X1.78 (2037)	yes

FAAC-GROUP.RU